



US  
Material Handler | F-Series

# 331/335 MHL



**154 hp (115 kW) (Diesel)**  
**90 kW (Electric)**



**max. 56,217 lbs**



**max. 39'4"**



**FUCHS**<sup>®</sup>  
A TEREX BRAND

# TECHNICAL DATA

## OPERATING WEIGHT WITHOUT ATTACHMENTS

MHL331 F	50,264–53,351 lbs
MHL335 F	52,691–56,217 lbs

## DIESEL ENGINE

EU-Stage V	
Manufacturer and model	Deutz TCD 4.1 L4
Design	4-cylinder in-line engine
Functionality	4-cycle diesel, common rail direct injection, turbocharged with intercooler, controlled exhaust gas recirculation, diesel particulate filter with continuous regeneration and SCR catalytic converter
Engine power	154 hp
Rated speed	2000 rpm
Displacement	250 cui
Cooling system	Water and charge air cooling with temperature controlled fan speed
Exhaust emission standard	EU-Stage V / EPA-Tier 4f
Fuel tank	69 gal Diesel
DEF / Urea tank	8.5 gal AdBlue

## ELECTRIC MOTOR

Power	90 kW
Total connected load	max. 118 kW
Motor start	Via soft start
Optional cable reel	Up to 164 ft metres (other lengths on request)

## ELECTRICAL SYSTEM

Alternator	28V / 100A
Operating voltage	24V
Battery	2 × 12V / 110Ah / 750A (according to EN)
Lighting system	2 × LED headlamps, turn indicators and tail lights
Optional equipment	11 kW or 13 kW DC generator with controls and insulation monitoring

## TRAVEL DRIVE

Hydrostatic travel drive via infinitely variable axial piston motor with directly mounted travel brake valve, two-speed manual gearshift, 4-wheel drive

Travel speed 1 <sup>st</sup> gear	max. 3.1 mph
Travel speed 2 <sup>nd</sup> gear	max. 11.2 mph
Gradeability	max. 40 %
Turning radius MHL331 F	26'
Turning radius MHL335 F	27'

## SLEWING DRIVE

Slewing ring	Internally geared, double-row ball turning ring
Drive	2-stage planetary gear with integrated multi-disc brake
Uppercarriage swing speed	0–7.5 rpm variable
Slewing lock	Electrically activated

## UNDERCARRIAGE

Front axle	Planetary drive axle with integrated multi-disc brake, rigidly mounted, max. steering angle: 29°
Rear axle	Oscillating planetary drive rear axle with integrated multi-disc brake and selectable oscillating lock
Outrigger	4-point stabilizers 2-point-stabilizers and support blade (MHL331)
Tires	10.00-20 solid rubber with intermediate rings

## BRAKES

Service brake	Hydraulic single-circuit braking system acting on all four wheel pairs (multi-disc brakes)
Parking brake	Electrically operated spring-loaded disc brake on the transmission, acting on both front and rear axle

## HYDRAULIC SYSTEM

Pump delivery rate	max. 100 gpm
Operating pressure	4641 / 5221 psi
Hydraulic oil tank	86 gal

## OPERATOR'S CAB

Cab	Infinitely variable hydraulic height-adjustment with eye level up to 17'4" m above ground Sound-deadened; ample thermal panoramic glass windows; windshield with pulldown sunblind; viewing window on cab roof; sliding window in cab door, sliding door
Air conditioning	Automatic air-conditioning. Infinitely variable heating with 8-speed fan, 10 adjustable air nozzles, including 4 in the roof lining, 3 defroster nozzles
Operator's seat	Air-sprung comfort seat with integrated headrest, safety belt, and lower lumbar support, optional seat heating. Allows comfortable working by offering universal adjustment possibilities of the seat position, the seat incline, and the position of the seat cushion in relation to the armrests and joysticks
Monitoring	Ergonomic layout; anti-glare instrumentation. Multifunction display, automatic monitoring and recording of abnormal operating conditions (including all hydraulic oil filters, hydraulic oil temperature (cold/hot), coolant temperature and charge air temperature, diesel particulate filter load, visual and audible warning indication with shutdown of pilot controls/engine power reduction. Diagnosis of individual sensors possible via the multifunction display. Rear view camera and side view camera
Noise level	Sound power level (ambience) L <sub>WA</sub> 99.1 dB(A) (metered) acc. to directive 2000/14/EC L <sub>WA</sub> 102 dB(A) (guaranteed) acc. to directive 2000/14/EC Sound pressure level (inside the cabin) acc. to standard ISO 6396 L <sub>PA</sub> 74 dB(A)

Certified in accordance with CE regulations

# EQUIPMENT

## DIESEL ENGINE

	Standard	Option
Intercooler and coolant radiator	●	
Direct electronic fuel injection / common rail	●	
Advanced automatic idle incl. engine shut-off function	●	
Engine preheating		●
Engine diagnostics interface	●	
Temperature-dependent fan drive	●	

## UNDERCARRIAGE

All-wheel drive	●	
Multi-disc brake	●	
Rear axle oscillating lock	●	
2-speed powershift transmission		●
4-point stabilizers	●	
Dozer blade in addition to 4-point stabilizers		●
2-point stabilizers and support blade (MHL331)		●
Stabilizer cylinders with integrated two-way check valves	●	
Piston rod protection on stabilizer cylinders	●	
Tool box	●	
Special paint (customer paint work)		●
Solid rubber tires 10.00-20 with intermediate rings	●	

## UPPERCARRIAGE

Separate cooling system for engine and hydraulic oil cooler	●	
Cooling system with temperature-dependent fan drive	●	
Fan drive reversing function	●	
Automatic central lubrication system	●	
Rear view camera	●	
Side view camera	●	
Travel alarm		●
Electric refuelling pump		●
Lighting protection		●
Special paint (customer paint work)		●

## CAB

Hydraulically adjustable cab	●	
Safety glass	●	
Sliding window in cab door	●	
Reinforced glass P5A (windscreen and roof panel)		●
Windshield washer system (windshield)	●	

## CAB

	Standard	Option
Roof washer system (roof panel)		●
Air-cushioned operator seat with headrest, seatbelt and lumbar support	●	
Seat heating		●
Joystick steering	●	
Steering column, height and tilt adjustable		●
Automatic air conditioning system	●	
Independent heating system		●
Multi-function display	●	
Document clip	●	
Front and FOPS Guard		●
12V transformer		●
Radio USB & Bluetooth (EU & USA)	●	
Radio CD & USB (other countries)	●	
12V socket		●
Fire extinguisher, dry powder		●
Travel alarm w/ rotating beacon		●

## OTHER EQUIPMENT

11 kW DC generator with controls		●
13 kW DC generator with controls		●
Close proximity range limiter for dipperstick	●	
Coolant and hydraulic oil level monitoring system	●	
Overload and working range monitoring		●
Filter system for attachments		●
Hose rupture valves for boom cylinder		●
Hose rupture valves for stick cylinder		●
Overload warning device		●
Quick coupling on dipperstick	●	
Dipperstick impact protection		●
Active cyclone prefilter (TOP AIR)		●
Hydraulic oil preheating		●
Lubrication of the grab suspension by central lubrication system	●	
Light packages LED		●
LED front headlights	●	
LED working lights cabin roof front	●	
Boom cylinder damping system (piston accumulator)		●
Fuchs Telematics System, incl. 2 years contract	●	

# DIMENSIONS

## 4-POINT STABILIZERS

All dimensions in ft & in

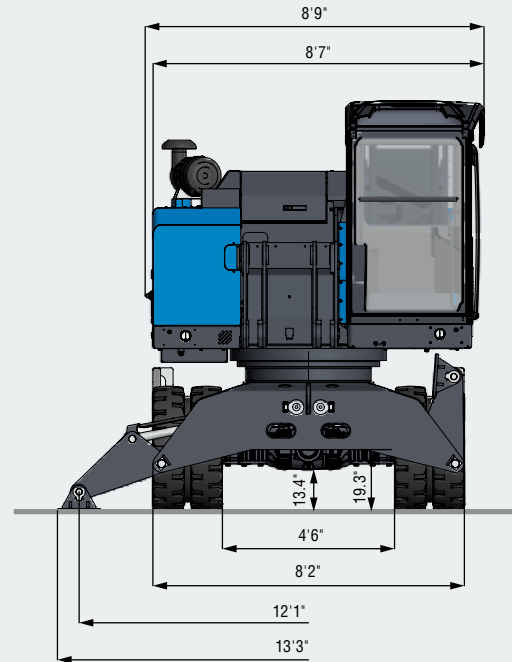
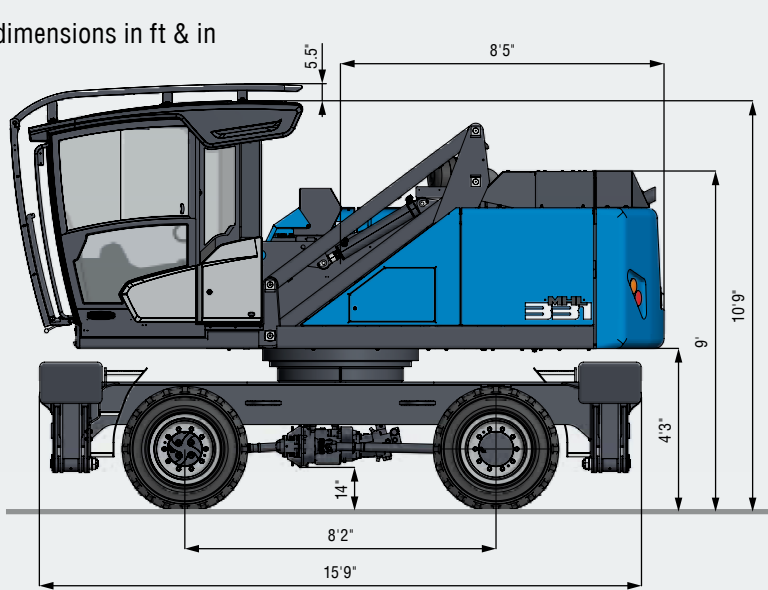

## DOZER BLADE IN ADDITION TO 4-POINT STABILIZERS

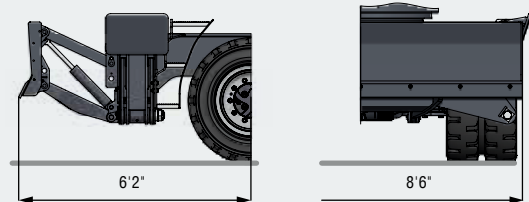

## 2-POINT STABILIZERS AND SUPPORT BLADE

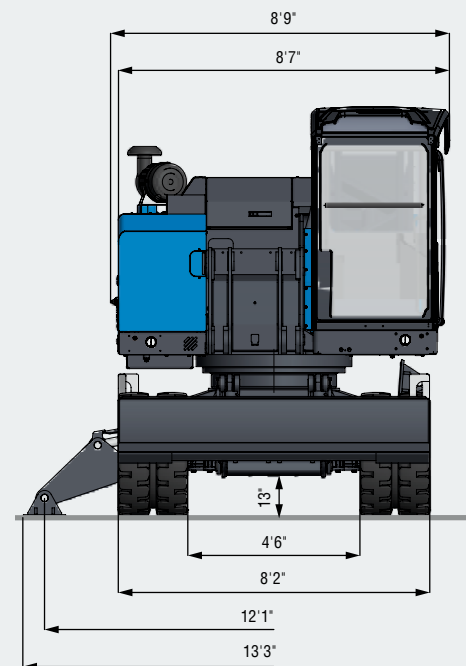
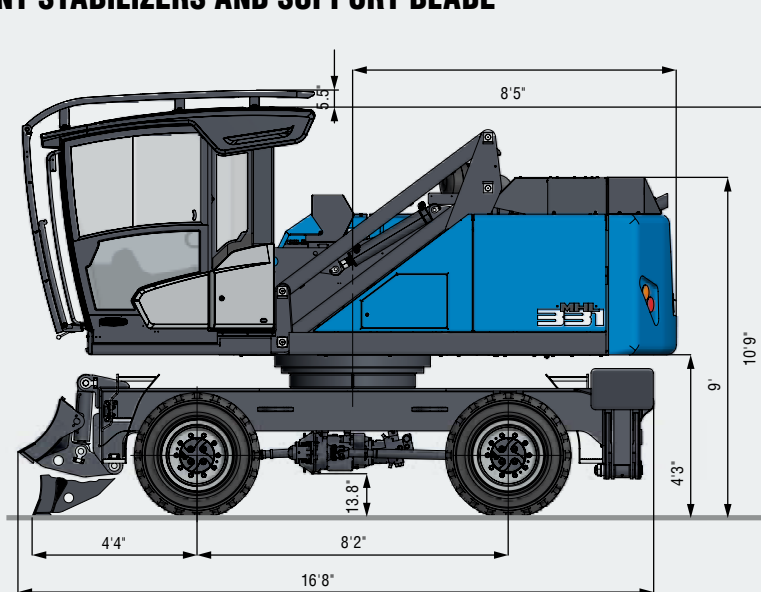

# TRANSPORT DIMENSIONS

All dimensions in ft & in

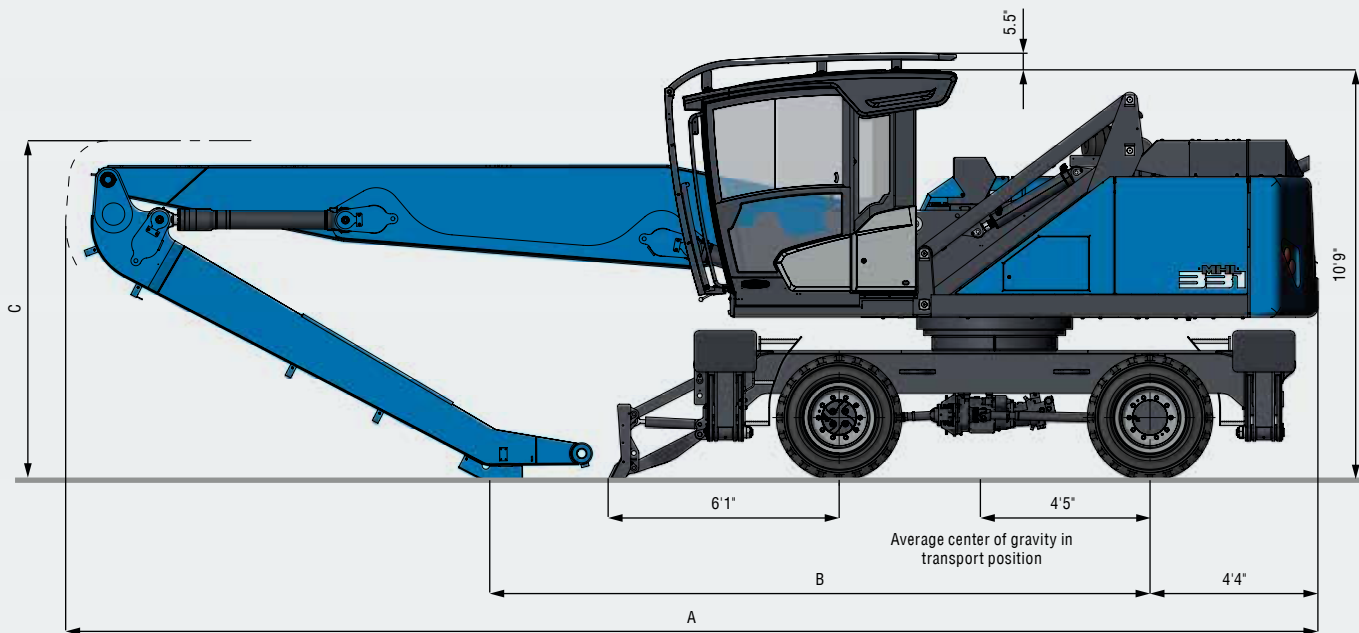

	35'1" **	36'1"	39'4"
A	33'2"	33'	33'
B	17'7"	17'4"	14'
C	9'	9'	10'

\*\* Multi-purpose stick

39'4"

Transport position with dozer blade  
Undercarriage rotated by 180°

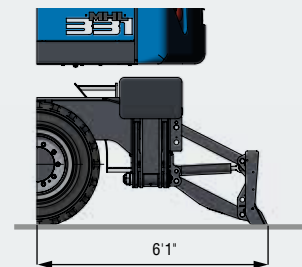



# 36'1" WITH DIPPER STICK

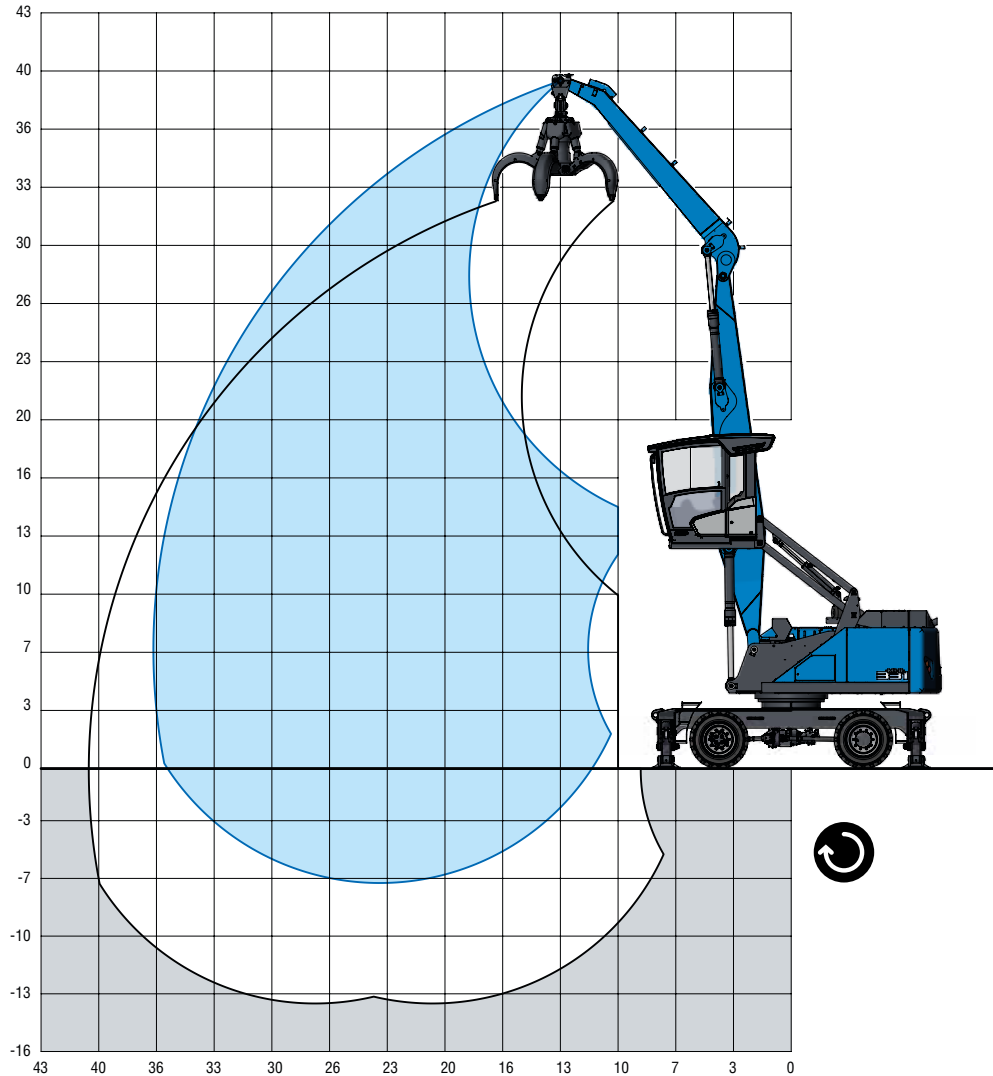

































## LOADING EQUIPMENT

Boom	21'3"
Dipper stick	14'4"
Cactus grab (open)	0.78 yd <sup>3</sup>

## RECOMMENDED ATTACHMENTS

Recommended attachments upon request

## LIFTING CAPACITY

		 									
		15 ft	20 ft	25 ft	30 ft	35 ft	25 ft	30 ft	35 ft	35 ft	
35 ft			(11,400)								
			12,300° (12,300°)								
			12,300° (12,300°)								
30 ft			(11,700)		(8,100)						
			13,900° (13,900°)		12,500° (12,500°)						
			13,900° (13,900°)		10,500 (12,500°)						
25 ft			(11,600)		(8,100)		(6,000)				
			14,000° (14,000°)		12,600° (12,600°)		9,400 (10,900°)				
			14,000° (14,000°)		10,500 (12,600°)		7,700 (10,900°)				
20 ft			(11,300)		(7,900)		(5,900)				
			14,900° (14,900°)		12,500° (13,100°)		9,300 (11,500)				
			14,900° (14,900°)		10,300 (13,100°)		7,700 (11,800°)				
15 ft			(16,700)		(7,600)		(5,700)		(4,500)		
		21,200° (21,200°)	16,600° (16,600°)		12,100 (13,900°)		9,200 (11,300)		7,200 (8,900)		
		21,200° (21,200°)	14,100 (16,600°)		9,900 (13,900°)		7,500 (11,800)		5,800 (9,200)		
10 ft			(15,100)		(7,200)		(5,500)		(4,400)		
		25,600° (25,600°)	16,400 (18,600°)		11,700 (14,700)		8,900 (11,100)		7,100 (8,800)		
		20,400 (25,600°)	13,200 (18,600°)		9,500 (15,000°)		7,200 (11,500)		5,700 (9,100)		
5 ft			(9,300)		(6,900)		(5,300)		(4,300)		
		22,300° (22,300°)	15,700 (20,100)		11,300 (14,200°)		8,700 (10,900)		7,000 (8,700)		
		18,800 (21,100)	12,400 (20,200°)		9,100 (14,800)		7,000 (11,300)		5,600 (9,000)		
0 ft			(8,900)		(6,600)		(5,200)		(4,200)		
		15,300° (15,300°)	15,200 (19,600)		11,000 (13,900)		8,500 (10,700)		6,900 (8,600)		
		15,300° (15,300°)	11,900 (20,300)		8,800 (14,400)		6,800 (11,100)		5,600 (8,900)		
-5 ft			(8,700)		(6,500)		(5,100)				
			14,900 (19,300)		10,900 (13,800)		8,500 (10,600)				
			11,700 (20,000)		8,600 (14,300)		6,800 (11,000)				
<b>max. reach 36'2"</b>											
6.6' ft									(4,000)		
									6,500 (8,100)		
									5,200 (8,400)		

### Important notes regarding the load capacities

The lift capacity values are stated in imperial pounds (lbs). The pump pressure is 5,221 psi. In accordance with ISO 10567 the lift capacity values represents 75% of the static tipping loads or 87% of the hydraulic lifting force (marked °). On solid and level ground the values apply to a swing range of 360°. The (...) values apply in the longitudinal direction of the undercarriage. The values for "not supported" only apply via the steering axle or the locked oscillating axle. The weights of the attached load hoisting equipment (grab, load hook, etc.) must be deducted from the lift capacity values. The working load of the lifting device must be observed. In accordance with the EN 474-5 for object handling application hose rupture valves on the boom and stick cylinders, an overload warning device and the lift capacity table in the cab are required. For object handling application the machine has to be supported on a level ground.



Reach

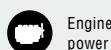

Engine power



Service weight without attachments



Center of rotation



Height



Undercarriage



4-point supported



# 39'4" WITH DIPPER STICK

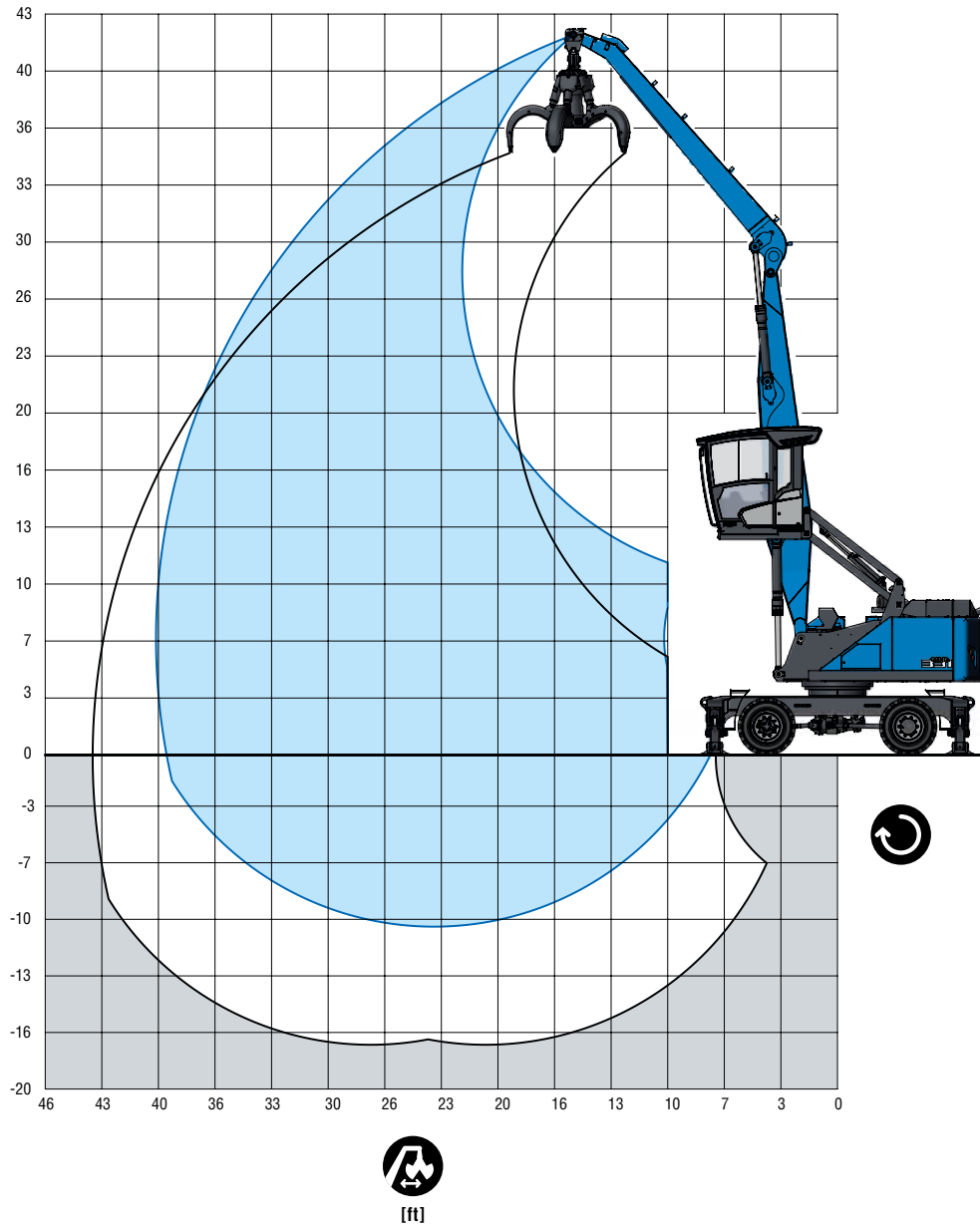



































## LOADING EQUIPMENT

Boom	21'3"
Dipper stick	17'8"
Cactus grab (open)	0.78 yd <sup>3</sup>

## RECOMMENDED ATTACHMENTS

Recommended attachments upon request

## LIFTING CAPACITY

							
			15 ft	20 ft	25 ft	30 ft	35 ft
35 ft					(8,300)		
					9,500° (9,500°)		
					9,500° (9,500°)		
30 ft				(8,500)		(6,200)	
					11,100° (11,100°)	8,900° (8,900°)	
					11,000 (11,100°)	8,000 (8,900°)	
25 ft				(8,400)		(6,200)	(4,600)
					11,200° (11,200°)	9,600 (10,500°)	6,900° (6,900°)
					10,900 (11,200°)	8,000 (10,500°)	6,100 (6,900°)
20 ft			(12,300)		(8,200)	(6,100)	(4,600)
			12,900° (12,900°)		11,700° (11,700°)	9,500 (10,700°)	7,400 (9,000)
			12,900° (12,900°)		10,700 (11,700°)	7,900 (10,700°)	6,100 (9,500)
15 ft			(11,200)		(7,900)	(5,900)	(4,500)
				14,600° (14,600°)	12,500 (12,600°)	9,300 (11,200°)	7,300 (8,900)
				14,600° (14,600°)	10,300 (12,600°)	7,700 (11,200°)	5,900 (9,400)
10 ft		(16,100)	(10,400)	(7,500)	(5,600)	(4,400)	(3,500)
		22,100° (22,100°)	16,800° (16,800°)	12,000 (13,800°)	9,100 (11,100)	7,100 (8,800)	5,700 (6,800°)
		21,700 (22,100°)	13,700 (16,800°)	9,800 (13,800°)	7,400 (11,700)	5,800 (9,200)	4,600 (6,300)
5 ft		(14,400)	(9,600)	(7,000)	(5,400)	(4,300)	(3,500)
		25,500 (26,500°)	16,000 (19,200°)	11,500 (14,300)	8,800 (10,800)	7,000 (8,600)	5,700 (6,800°)
		19,600 (26,500°)	12,800 (18,900)	9,200 (14,900°)	7,100 (11,300)	5,600 (9,000)	4,600 (6,800°)
0 ft		(13,400)	(9,100)	(6,700)	(5,200)	(4,100)	
		20,400° (20,400°)	15,300 (19,500)	11,000 (13,800)	8,500 (10,600)	6,900 (8,500)	
		18,200 (19,800)	12,000 (20,300°)	8,800 (14,500)	6,800 (11,100)	5,500 (8,900)	
-5 ft		(12,700)	(8,600)	(6,400)	(5,000)	(4,100)	
		16,400° (16,400°)	14,900 (19,100)	10,800 (13,600)	8,400 (10,400)	6,800 (8,400)	
		16,400° (16,400°)	11,600 (19,900)	8,500 (14,200)	6,600 (10,900)	5,400 (8,800)	
<b>max. reach 39'4"</b>							
6.6' ft						(3,400)	
						5,700 (6,500°)	
						4,600 (6,500°)	

### Important notes regarding the load capacities

The lift capacity values are stated in imperial pounds (lbs). The pump pressure is 5,221 psi. In accordance with ISO 10567 the lift capacity values represents 75% of the static tipping loads or 87% of the hydraulic lifting force (marked °). On solid and level ground the values apply to a swing range of 360°. The (...) values apply in the longitudinal direction of the undercarriage. The values for "not supported" only apply via the steering axle or the locked oscillating axle. The weights of the attached load hoisting equipment (grab, load hook, etc.) must be deducted from the lift capacity values. The working load of the lifting device must be observed. In accordance with the EN 474-5 for object handling application hose rupture valves on the boom and stick cylinders, an overload warning device and the lift capacity table in the cab are required. For object handling application the machine has to be supported on a level ground.



Reach

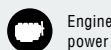

Engine power



Service weight without attachments



Center of rotation



Height



Undercarriage



4-point supported



# 35'1" WITH DIPPER STICK

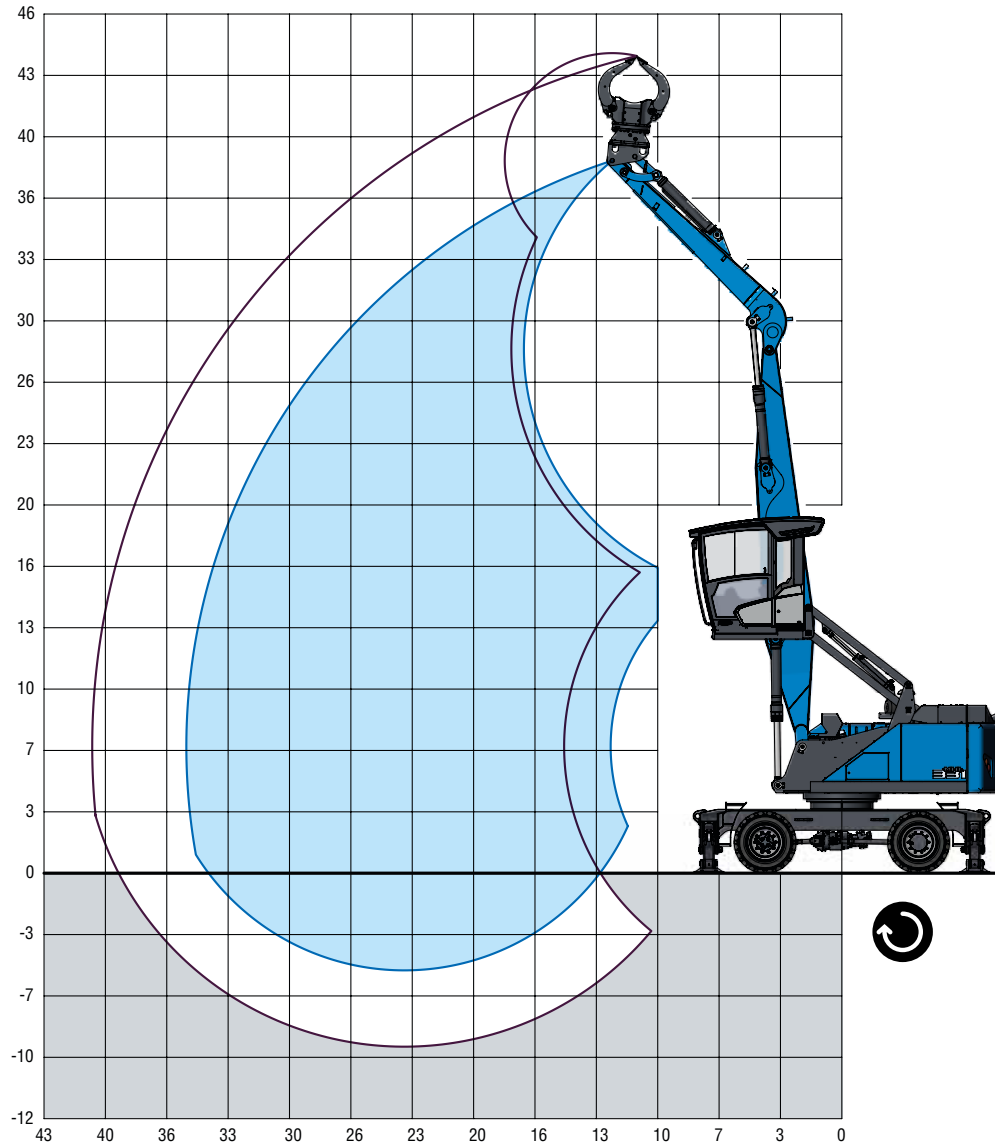

[ft]











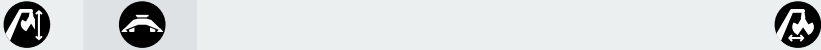

















## LOADING EQUIPMENT

Boom	21'3"
Dipper stick	13'1"
Sorting grapple	0.59 yd <sup>3</sup>

## RECOMMENDED ATTACHMENTS

Recommended attachments upon request

## LIFTING CAPACITY

						
		15 ft	20 ft	25 ft	30 ft	35 ft
30 ft			(11,000)	(7,500)		
			13,900° (13,900°)	11,100° (11,100°)		
			13,900° (13,900°)	9,800 (11,100°)		
25 ft			(11,000)	(7,500)	(5,300)	
			14,000° (14,000°)	12,100 (12,400°)	8,800° (8,800°)	
			14,000° (14,000°)	9,800 (12,400°)	7,000 (8,800°)	
20 ft		(17,000)	(10,600)	(7,300)	(5,300)	
		18,300° (18,300°)	14,900° (14,900°)	11,900 (12,800°)	8,700 (10,800)	
		18,300° (18,300°)	14,000 (14,900°)	9,600 (12,800°)	7,000 (11,300)	
15 ft		(15,700)	(10,000)	(7,000)	(5,200)	
		21,600° (21,600°)	16,600 (16,700°)	11,500 (13,900°)	8,600 (10,700)	
		21,200 (21,600°)	13,200 (16,500)	9,200 (13,500)	6,800 (11,100)	
10 ft		(14,100)	(9,300)	(6,800)	(5,000)	(3,800)
		25,200 (26,100°)	15,700 (18,300°)	11,100 (13,900)	8,400 (10,400)	6,600 (8,200)
		19,100 (25,700)	12,300 (18,300°)	8,800 (14,400°)	6,600 (10,800)	5,100 (8,500)
5 ft		(12,800)	(8,600)	(6,300)	(4,800)	(3,800)
		16,900° (16,900°)	15,000 (19,200)	10,700 (13,500)	8,200 (10,200)	6,500 (8,100)
		16,300 (16,300)	11,500 (19,600°)	8,300 (14,000)	6,300 (10,600)	5,000 (8,400)
0 ft		(12,400)	(8,300)	(6,100)	(4,700)	
		13,800° (13,800°)	14,500 (18,700)	10,400 (13,200)	8,000 (10,100)	
		13,800° (13,800°)	11,100 (19,400)	8,000 (13,700)	6,200 (10,400)	
-5 ft				(5,900)		
				10,300 (13,100)		
				7,900 (13,600)		
						<b>max. reach 35'1"</b>
6.6' ft						(3,700)
						6,300 (8,000)
						4,900 (8,200)

### Important notes regarding the load capacities

The lift capacity values are stated in imperial pounds (lbs). The pump pressure is 5,221 psi. In accordance with ISO 10567 the lift capacity values represents 75% of the static tipping loads or 87% of the hydraulic lifting force (marked °). On solid and level ground the values apply to a swing range of 360°. The (...) values apply in the longitudinal direction of the undercarriage. The values for "not supported" only apply via the steering axle or the locked oscillating axle. The weights of the attached load hoisting equipment (grab, load hook, etc.) must be deducted from the lift capacity values. The working load of the lifting device must be observed. In accordance with the EN 474-5 for object handling application hose rupture valves on the boom and stick cylinders, an overload warning device and the lift capacity table in the cab are required. For object handling application the machine has to be supported on a level ground.



Reach

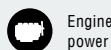

Engine power



Service weight without attachments



Center of rotation



Height



Undercarriage



4-point supported

# DIMENSIONS

## 4-POINT STABILIZERS

All dimensions in ft & in

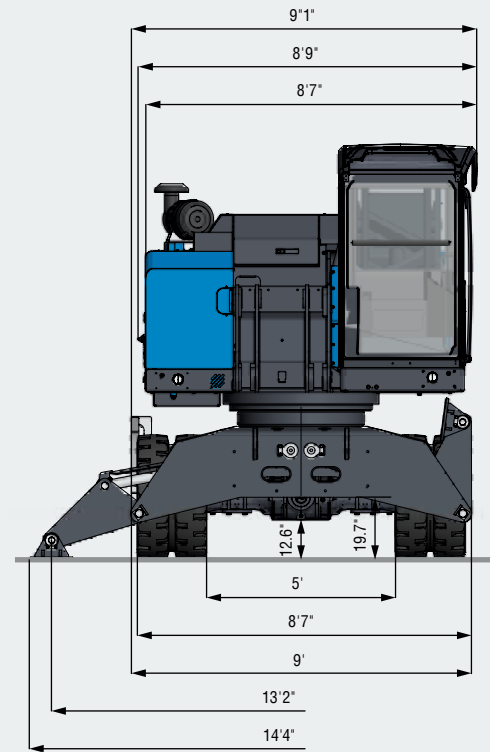
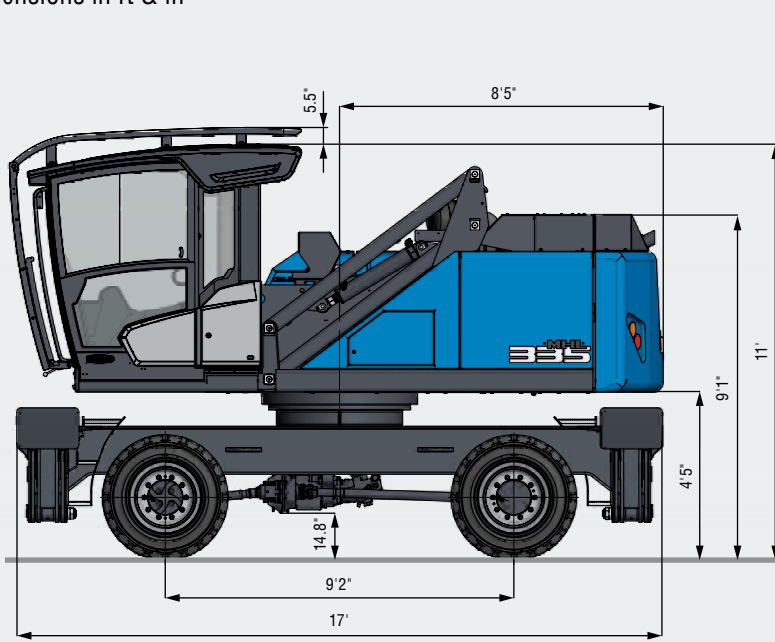



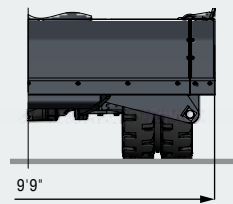
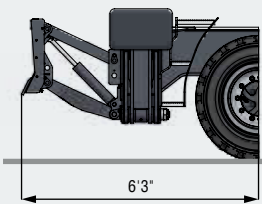

## DOZER BLADE IN ADDITION TO 4-POINT STABILIZERS

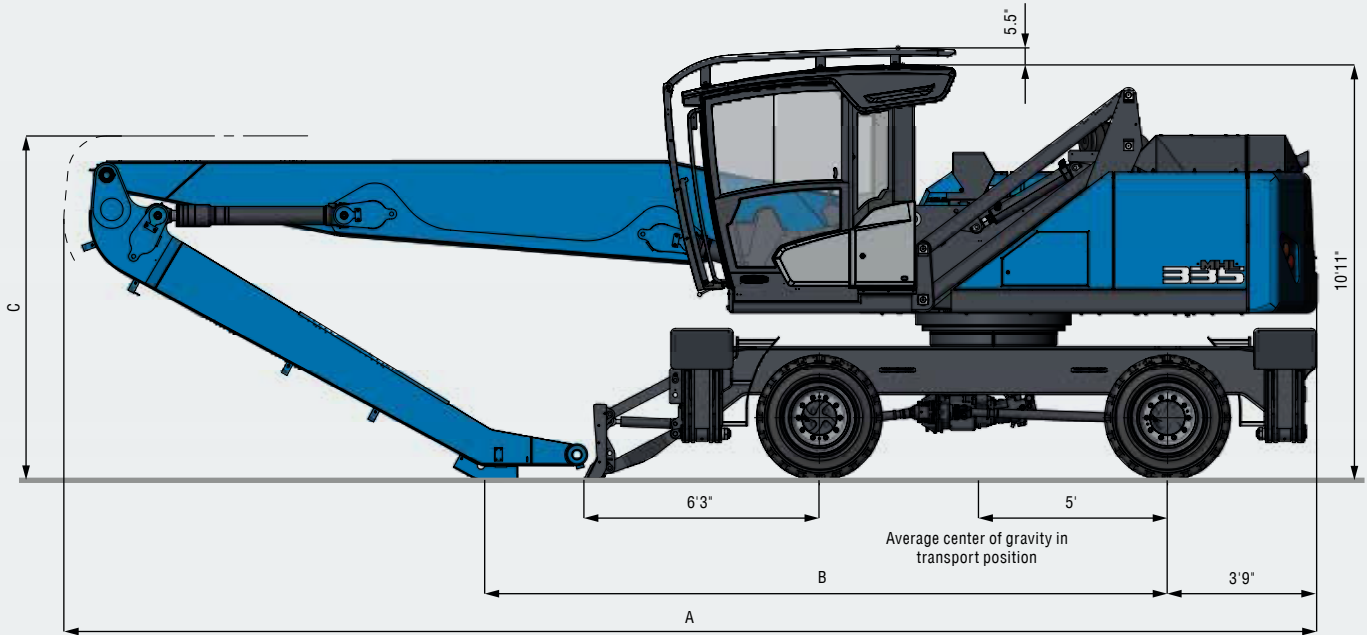

# TRANSPORT DIMENSIONS

All dimensions in ft & in



	 35'1"***	 36'1"	 39'4"
A	33'2"	33'	33'
B	18'3"	18'	14'2"
C	9'1"	9'1"	9'7"

\*\* Multi-purpose stick

## 39'4"

Transport position with dozer blade  
Undercarriage rotated by 180°

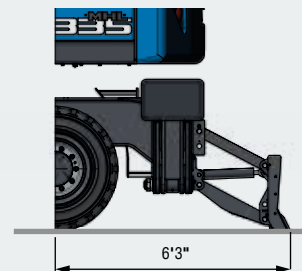



# 36'1" WITH DIPPER STICK

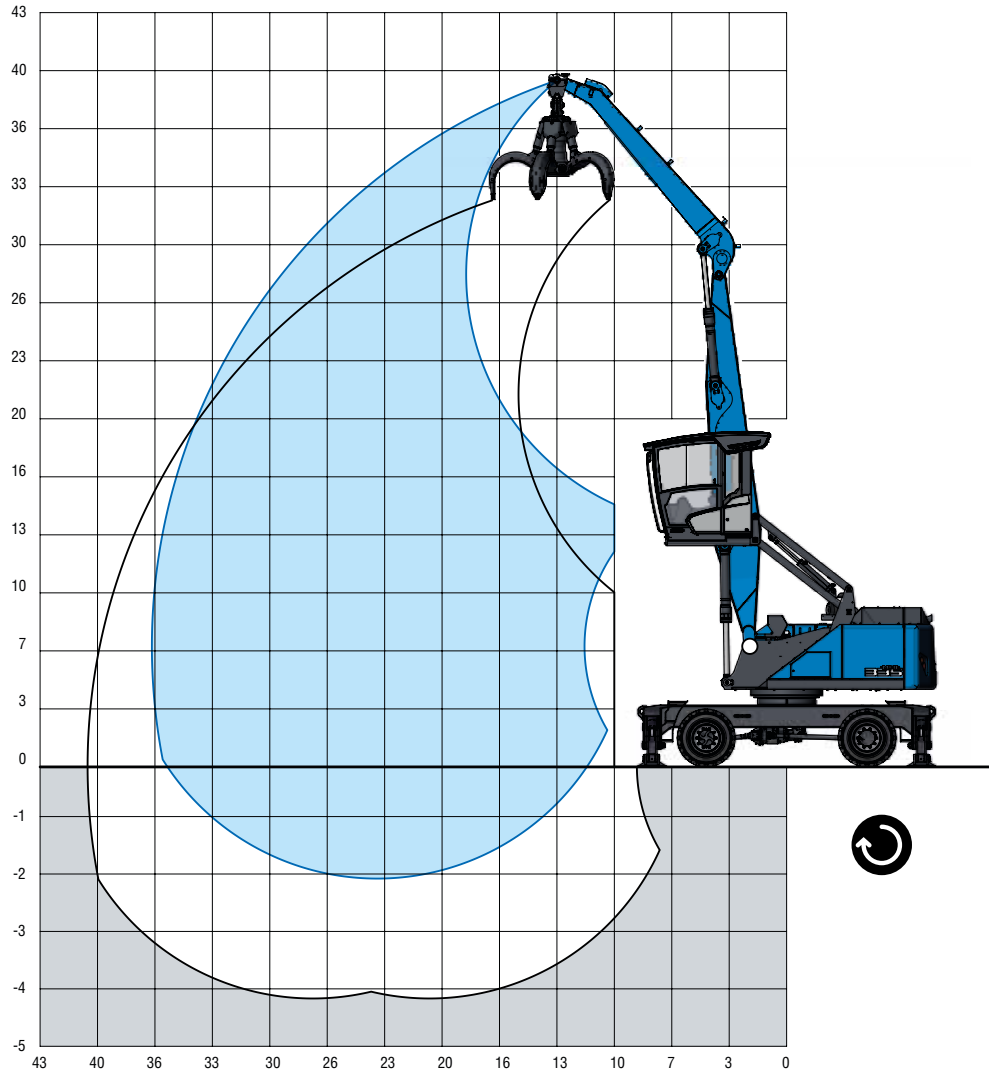

## LOADING EQUIPMENT

Boom	21'3"
Dipper stick	14'4"
Cactus grab (open)	0.78 yd <sup>3</sup>

## RECOMMENDED ATTACHMENTS

Recommended attachments upon request

## LIFTING CAPACITY

			15 ft	20 ft	25 ft	30 ft	35 ft	
35 ft				(12,640°)				
				12,640° (12,640°)				
30 ft				(13,910)	(9,710)			
				14,050° (14,050°)	12,580° (12,580°)			
25 ft				(13,830)	(9,710)	(7,210)		
				14,160° (14,160°)	12,900° (12,900°)	11,040 (11,120°)		
20 ft				(13,470)	(9,520)	(7,150)		
				15,170° (15,170°)	13,390° (13,390°)	10,970 (12,140°)		
15 ft			(20,120)	(12,860)	(9,200)	(6,980)	(5,490)	
			21,430° (21,430°)	16,940° (16,940°)	14,280° (14,300°)	10,790 (12,560°)	8,520 (10,150°)	
10 ft			(18,430)	(12,110)	(8,800)	(6,770)	(5,390)	
			26,120° (26,120°)	19,080° (19,080°)	13,840 (15,400°)	10,560 (13,100°)	8,420 (10,440)	
5 ft			(17,020)	(11,420)	(8,430)	(6,560)	(5,290)	
			21,490° (21,490°)	18,730 (20,880°)	13,430 (16,330°)	10,330 (12,910)	8,310 (10,330)	
0 ft			(15,390°)	(10,970)	(8,150)	(6,400)	(5,230)	
			15,390° (15,390°)	18,210 (21,630°)	13,120 (16,640)	10,160 (12,730)	8,250 (10,260)	
-5 ft				(10,790)	(8,020)	(6,340)		
				18,000 (20,990°)	12,940 (16,340°)	10,090 (16,340)		
								<b>max. reach 36'1"</b>
6.9' ft							(4,950)	
							7,760 (8,540°)	

### Important notes regarding the load capacities

The lift capacity values are stated in imperial pounds (lbs). The pump pressure is 5,221 psi. In accordance with ISO 10567 the lift capacity values represents 75% of the static tipping loads or 87% of the hydraulic lifting force (marked °). On solid and level ground the values apply to a swing range of 360°. The (...) values apply in the longitudinal direction of the undercarriage. The values for "not supported" only apply via the steering axle or the locked oscillating axle. The weights of the attached load hoisting equipment (grab, load hook, etc.) must be deducted from the lift capacity values. The working load of the lifting device must be observed. In accordance with the EN 474-5 for object handling application hose rupture valves on the boom and stick cylinders, an overload warning device and the lift capacity table in the cab are required. For object handling application the machine has to be supported on a level ground.



Reach

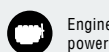

Engine power



Service weight without attachments



Center of rotation



Height



Undercarriage



4-point supported



# 39'4" WITH DIPPER STICK

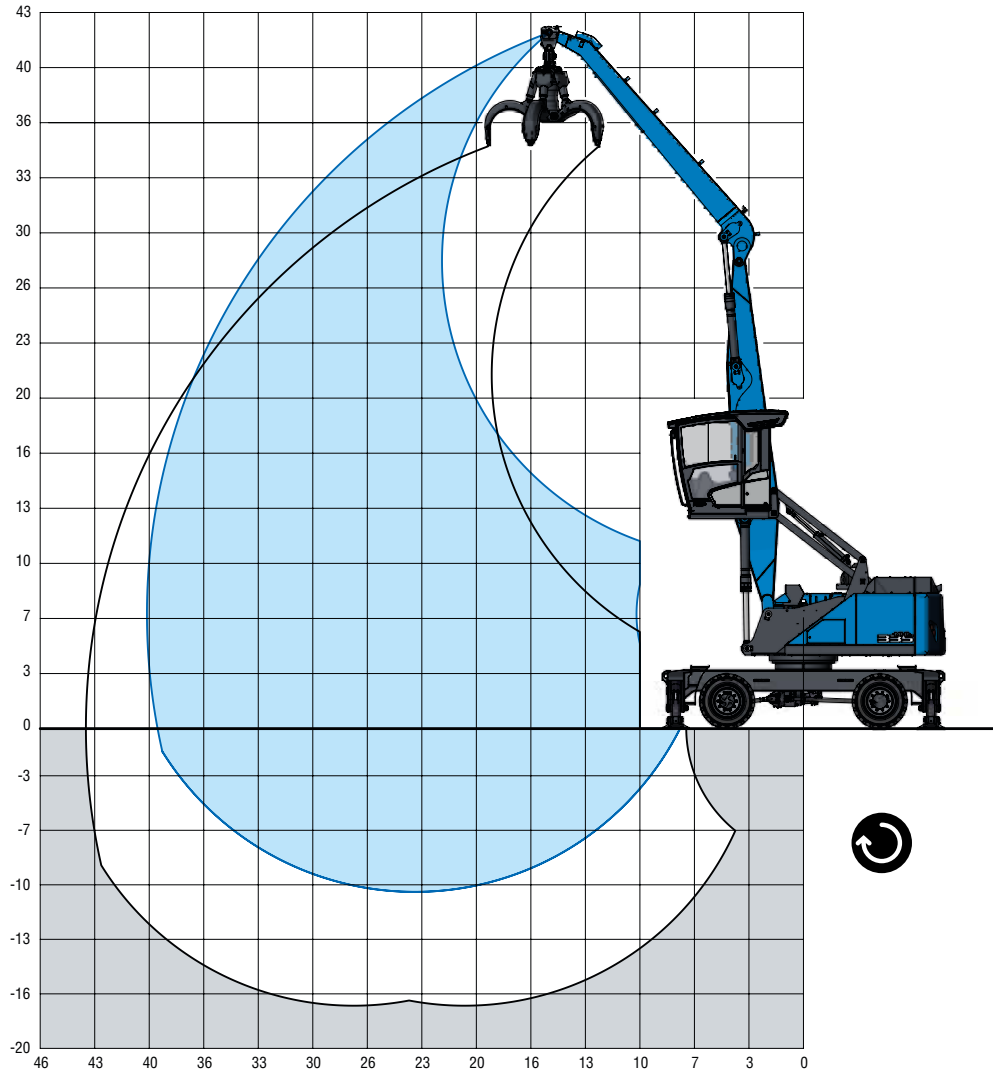















## LOADING EQUIPMENT

Boom	21'3"
Dipper stick	17'9"
Cactus grab (open)	0.78 yd <sup>3</sup>

## RECOMMENDED ATTACHMENTS

Recommended attachments upon request

## LIFTING CAPACITY

							
		15 ft	20 ft	25 ft	30 ft	35 ft	
35 ft				(9,750°) 9,750° (9,750°)			
30 ft				(10,070) 11,330° (11,330°)	(7,420) 9,110° (9,110°)		
25 ft				(10,030) 11,360° (11,360°)	(7,440) 10,770° (10,770°)	(5,690) 7,100° (7,100°)	
20 ft				(9,820) 11,930° (11,930°)	(7,330) 11,040° (11,040°)	(5,670) 8,720 (9,840°)	
15 ft			(13,400) 14,800° (14,800°)	(9,470) 12,930° (12,930°)	(7,130) 10,960 (11,580°)	(5,560) 8,620 (10,570°)	
10 ft		(19,560) 22,400° (22,400°)	(12,580) 17,140° (17,140°)	(9,020) 14,100° (14,190°)	(6,870) 10,680 (12,270°)	(5,420) 8,460 (10,490)	(4,390) 6,400° (6,400°)
5 ft		(17,750) 27,150° (27,150°)	(11,730) 19,110 (19,450°)	(8,560) 13,590 (15,430°)	(6,600) 10,390 (12,940°)	(5,270) 8,300 (10,330)	(4,330) 6,850° (6,870°)
0 ft		(16,570) 19,980° (19,980°)	(11,070) 18,360 (21,000°)	(8,180) 13,170 (16,300°)	(6,370) 10,140 (12,720)	(5,150) 8,170 (10,190)	
-5 ft		(16,080) 16,440° (16,440°)	(10,700) 17,930 (21,340°)	(7,930) 12,890 (16,410°)	(6,220) 9,980 (12,550)	(5,080) 8,090 (10,110)	
-10 ft				(7,840) 12,790 (15,770°)	(6,400) 10,160 (12,730)		
							<b>max. reach 39'4"</b>
6.9' ft							(4,320) 6,550° (6,550°)

### Important notes regarding the load capacities

The lift capacity values are stated in imperial pounds (lbs). The pump pressure is 5,221 psi. In accordance with ISO 10567 the lift capacity values represents 75% of the static tipping loads or 87% of the hydraulic lifting force (marked °). On solid and level ground the values apply to a swing range of 360°. The (...) values apply in the longitudinal direction of the undercarriage. The values for "not supported" only apply via the steering axle or the locked oscillating axle. The weights of the attached load hoisting equipment (grab, load hock, etc.) must be deducted from the lift capacity values. The working load of the lifting device must be observed. In accordance with the EN 474-5 for object handling application hose rupture valves on the boom and stick cylinders, an overload warning device and the lift capacity table in the cab are required. For object handling application the machine has to be supported on a level ground.



Reach



Engine power



Service weight without attachments



Center of rotation



Height



Undercarriage



4-point supported



# 35'1" WITH MULTI-PURPOSE STICK

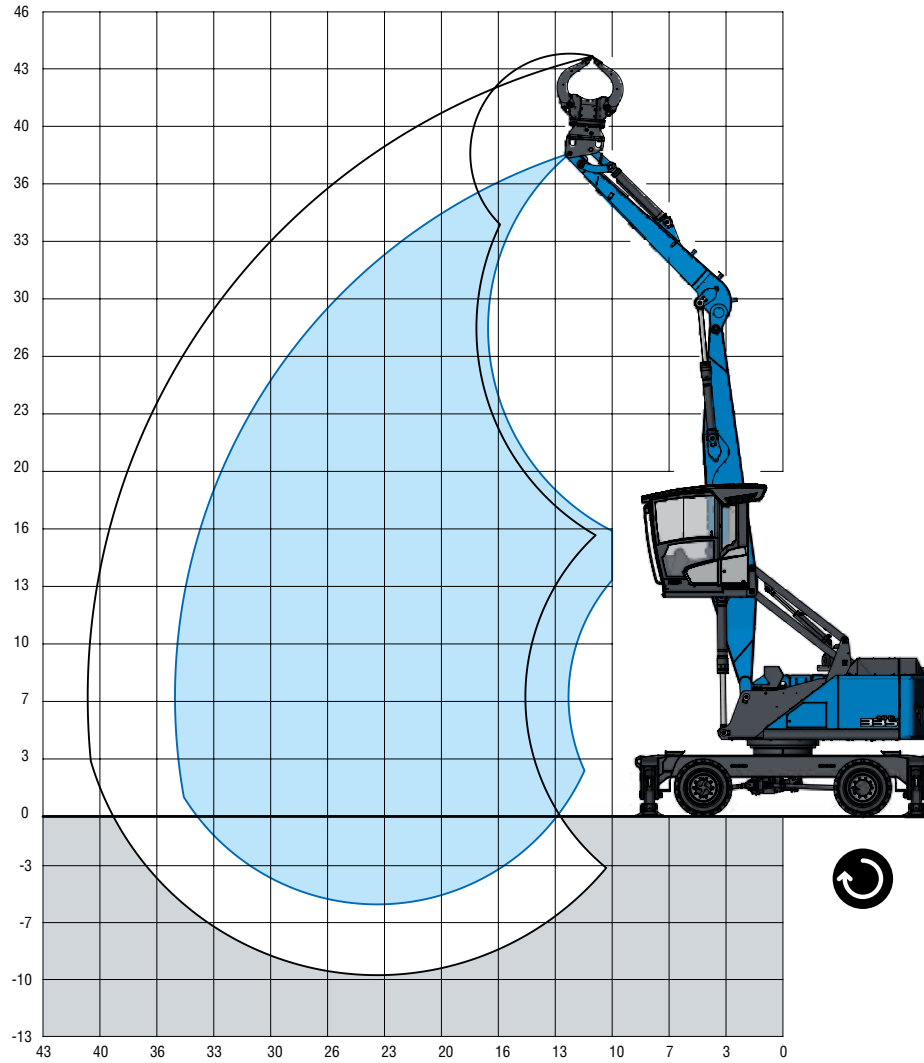























## LOADING EQUIPMENT

Boom	21'3"
Dipper stick	13'1"
Sorting grapple	0.59 yd <sup>3</sup>

## RECOMMENDED ATTACHMENTS

Recommended attachments upon request

## LIFTING CAPACITY

							
			15 ft	20 ft	25 ft	30 ft	35 ft
35 ft				(11,060°) 11,060° (11,060°)			
30 ft				(13,250°) 14,220° (14,220°)	(9,060°) 11,420° (11,420°)		
25 ft				(13,170°) 14,280° (14,280°)	(9,100°) 12,790° (12,790°)	(6,600°) 9,180° (9,180°)	
20 ft			(18,470°) 18,470° (18,470°)	(12,790°) 15,250° (15,250°)	(8,910°) 13,220° (13,220°)	(6,560°) 10,380 (11,840°)	
15 ft			(19,170°) 22,090° (22,090°)	(12,150°) 16,950° (16,950°)	(8,580°) 13,650 (14,060°)	(6,410°) 10,210 (12,190°)	
10 ft			(17,420°) 26,530° (26,530°)	(11,380°) 18,760 (18,950°)	(8,180°) 13,210 (15,050°)	(6,200°) 9,990 (12,570)	(4,850°) 7,880 (9,900)
5 ft			(16,130°) 16,490° (16,490°)	(10,720°) 18,010 (20,470°)	(7,820°) 12,810 (15,830°)	(6,000°) 9,770 (12,350)	(4,770°) 7,790 (9,810)
0 ft			(13,950°) 13,950° (13,950°)	(10,330°) 17,550 (20,850°)	(7,570°) 12,540 (16,030)	(5,870°) 9,630 (12,190)	
-5 ft					(7,470°) 12,430 (15,340°)		
							<b>max. reach 35'1"</b>
6.9' ft							(4,680°) 7,630 (8,950°)



### Important notes regarding the load capacities

The lift capacity values are stated in imperial pounds (lbs). The pump pressure is 5,221 psi. In accordance with ISO 10567 the lift capacity values represents 75% of the static tipping loads or 87% of the hydraulic lifting force (marked °). On solid and level ground the values apply to a swing range of 360°. The (...) values apply in the longitudinal direction of the undercarriage. The values for "not supported" only apply via the steering axle or the locked oscillating axle. The weights of the attached load hoisting equipment (grab, load hock, etc.) must be deducted from the lift capacity values. The working load of the lifting device must be observed. In accordance with the EN 474-5 for object handling application hose rupture valves on the boom and stick cylinders, an overload warning device and the lift capacity table in the cab are required. For object handling application the machine has to be supported on a level ground.



Reach



Engine power



Service weight without attachments



Center of rotation



Height



Undercarriage



4-point supported



**WORKS FOR YOU.™**

[www.terex-fuchs.com](http://www.terex-fuchs.com)

May 2019. Product specifications and prices are subject to change without notice or obligation. The photographs and/or drawings in this document are for illustrative purposes only. Refer to the appropriate Operator's Manual for instructions on the proper use of this equipment. Failure to follow the appropriate Operator's Manual when using our equipment or to otherwise act irresponsibly may result in serious injury or death. The only warranty applicable to our equipment is the standard written warranty applicable to the particular product and sale and Terex makes no other warranty, express or implied. © Terex Corporation 2019 · Terex, the Terex Crown design, Fuchs and Works For You are trademarks of Terex Corporation or its subsidiaries.

Terex® Deutschland GmbH | Industriestraße 3 | 76669 Bad Schönborn | Germany | Fon: +49 (0) 7253 84-0 | Fax: +49 (0) 7253 84-102 | [info@terex-fuchs.com](mailto:info@terex-fuchs.com)

